

 ZEBRONICS

Smart LED Projector

 **Pixa**
Play **27**



User Manual

www.zebronics.com

Dear Customer,

Thank you for purchasing the **ZEB-Pixaplay 27 LED Projector**. Please read the user manual carefully before usage & save it for future reference.

Note:

- *To provide a stable power supply, kindly use the cable provided with the product and connect to a AC 100-240V, 50/60Hz power source.*
- *Avoid the self-disassembly of the product as it results in voiding the product's warranty.*
- *Avoid looking directly at the projector lens while it is active.*
- *Make sure that the projector's air vents are not blocked while in use. The device must be kept in a well ventilated surrounding for proper functioning.*
- *It is recommended to power OFF the projector after a continuous usage of 6 hours maximum.*
- *Place the projector away from water or other liquids. Avoid water accumulation and ensure good ventilation.*
- *In case of enquiry regarding the projector, email us at enquiry@zebronics.com or contact us at 044 4000 0004.*

Features:

- Multi Connectivity (BT v5.1 | HDMI IN x 2 | USB x 2 | AUX OUT)
- Home Theater Projectors for Movies, TV & Gaming etc.
- Powerful Speaker
- Wide Compatibility
- Ceiling Mountable
- Remote Control
- Electronics Focus (via remote or Projector)
- Auto Focus Technology
- Auto Keystone Adaptation
- Miracast and IOS Screen Mirroring
- Dual band Connectivity (2.4GHz & 5GHz)
- FHD 1080p (Native)
- 30,000h lifelong LED lamp
- APP Support
- Quad Core Processor
- Touch Control

Specification:

Screen size	: 96.5 - 569cm
Native Resolution	: 1920 x 1080 FHD
Max. Supported Resolution	: 1080p (max)
RAM	: 1 GB
Core Processor	: Quad Core Processor
Storage (ROM)	: 32 GB
Android Version	: 9.0
Wi-Fi Connectivity	: Dual band Connectivity (2.4GHz & 5GHz)

Bluetooth Version	: v5.1
Display Technology	: LED
Lifespan	: 30,000h
Brightness	: 7500 lumens
Contrast ratio	: 1000:1
Projection Distance	: 1.2m - 6.5m
Port Interface	: AUX OUT, 2 x USB, 2 x HDMI
Video file format	: AVI, MP4, MPG, MPEG1, MPEG2, MKV, WMV, MOV, FLV, H.264
Input Voltage	: AC 100-240V, 50/60Hz
Product Dimension (W x D x H)	: 29.5 x 22.5 x 10 cm
Net. weight	: 2.3 kg

Package Contents:

Projector	: 1 U
Remote Control	: 1 U
Power Cord	: 1 U
Cotton Swab Pack	: 1 U
HDMI Cable	: 1 U
Fabric Cloth	: 1 U
Backpack	: 1 U
QR Code Guide	: 1 U

Product Description

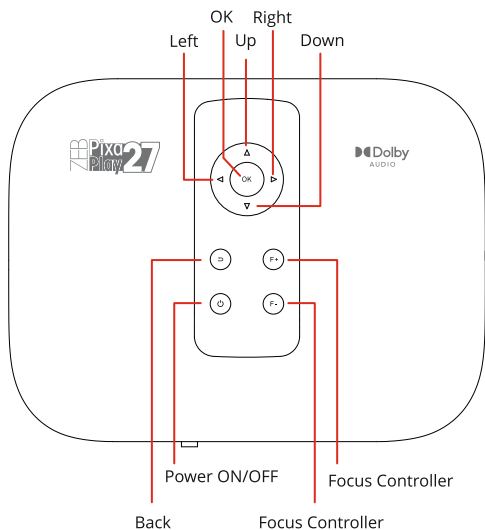
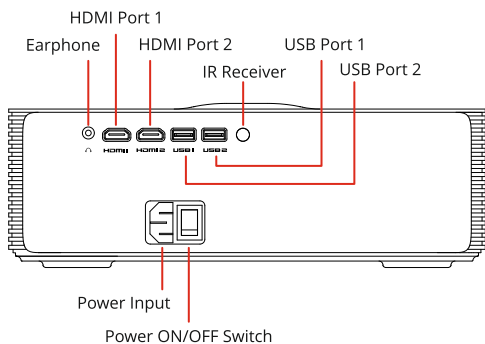

Remote Control

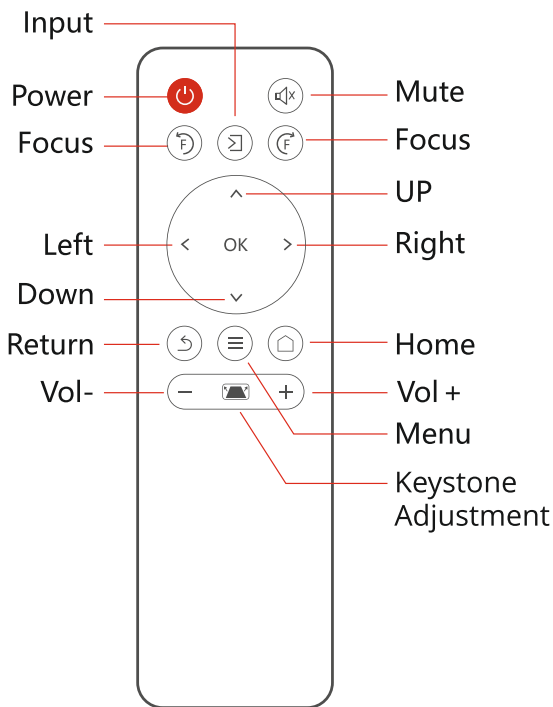

NOTE:

1. To avoid power shortage, please do not mix and use the old and new battery.
2. To avoid battery leakage corrosion, if do not use remote control for a long time, please take the battery out.

Projector Interface

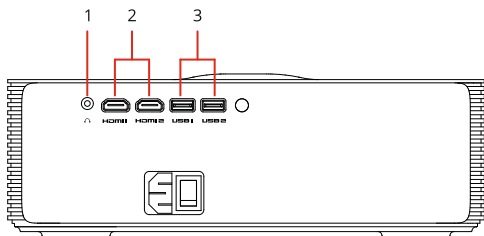

1



2

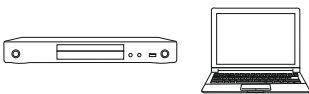

3



Setting Up the Projector

1. Connect the adapter to the socket and the AC pin to the projector and turn it ON.
2. Before turning ON, make sure to place it in a flat surface for a proper projection then "Touch" the power button / turn it on by using the remote.
3. Align the projector as shown in the image below to ensure proper projection.

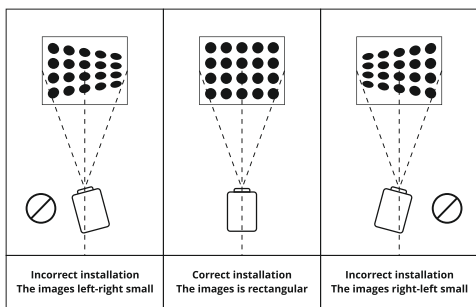

Focus Adjustment

Note: There is no manual focus, it has only electronic focus. Do not rotate the lens or it will be damaged.



Once the projector turns ON, wait till it gets loaded. Only after a proper boot-up you'll be able to adjust the focus using the focus control buttons of the remote as mentioned in the image.

Projection

The projection adjustments like keystone adjustment, Zoom Out can be done using the projection tabs in the settings.

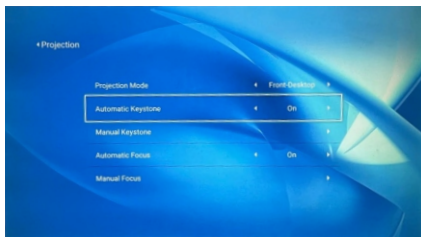

1. Digital 4D keystone : While most of the projector comes with only manual vertical trapezoidal correction, resulting in blurred corners, **ZEB-PixaPlay 27** has digital horizontal as well as vertical keystone correction, giving you sharp and clear corners.
2. Digital Zoom : with a click of remote, you can scale down the image to perfectly fit within the screen frame.

Android Home

1. Once the projector is turned on you'll be directed to the home-screen.
2. The Home screen displays a list of installed apps, Play Store, Settings menu, File manager, Inputsource - HDMI etc.

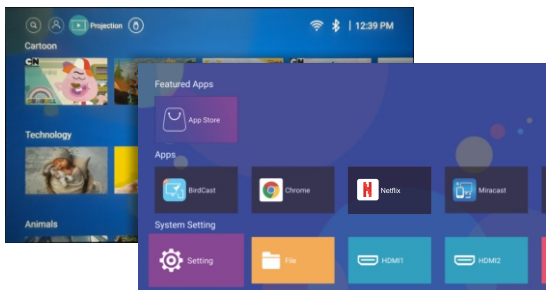

Android Settings

Open the homepage, select settings main menu found in the last section of the homepage. This settings houses the following submenus: Network settings, Bluetooth settings, projection settings, language settings, date settings, application settings, system update, other settings.

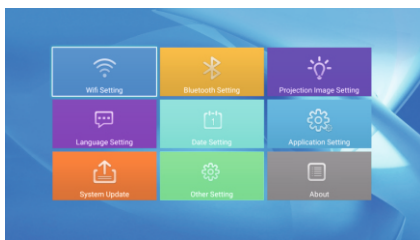
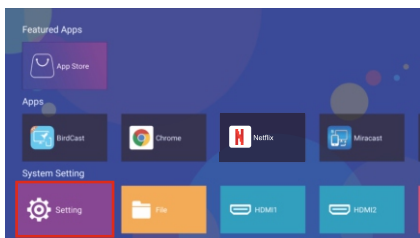

USB Connections

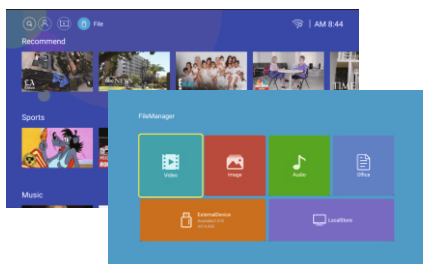
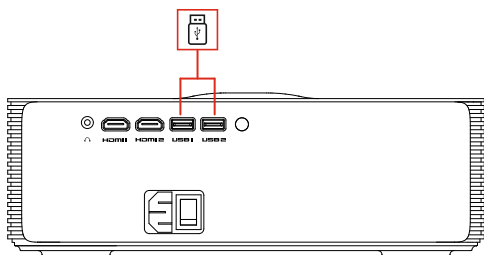

Connect the USB drive with the content to the projector. You can access the USB drive by either clicking on the USB icon that pops up on the homepage or by using the file menu next to the settings icon. The above mentioned screen will pop up. You can easily access the media either category wise-videos / Photos or from the folder itself and play them.

HDMI & AV Interface

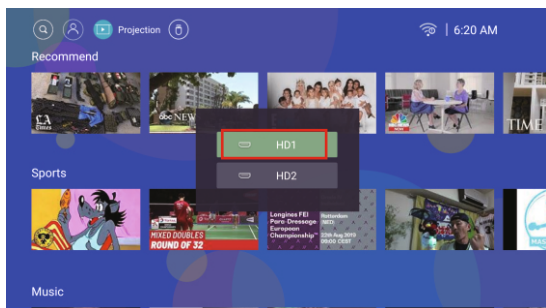
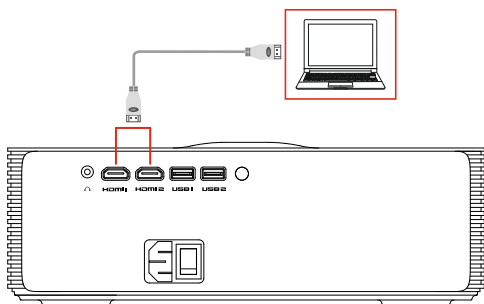

Once the HDMI interface is connected to the projector, you will need to select the specific signal source as the input. After connecting the content played on the source will be streamed on the projector.

Projector distance & size

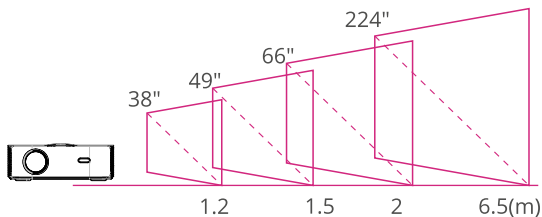

Note:

Due to optical device error of about 3%, the above data is for reference only, Please use actual measurement when installing the device.

ISO 9001:2015 Certified Company

www.zebronics.com