

 ZEBRONICS

Trimmer

ZEB **HT115**



User Manual

www.zebtronics.com

Thank you for purchasing the **ZEB-HT115** Trimmer. Please read the user manual carefully before usage & save it for future reference.

Note:

- Use this product only for its intended use.
- Do not dismantle the trimmer in order to avoid electrical shock & other accidents and this may lead to devoid of warranty.
- Keep the product and cords away from high temperature and high humidity places.
- Avoid using and charging the product with wet hands.
- Do not throw the product into fire.

Features:

- Upto 120 mins Cordless use
- Corded & Cordless usage
- Multistage Guide comb
- Washable Blades & Attachments
- Self Sharpening Stainless steelblades
- LED Indicator
- Easy to hold design
- Built in Rechargeable battery
- 90 mins USB Rapid Charge
- With Charging Dock

Specifications:

Input Voltage	: DC 5V
Usage type	: Corded & Cordless
Trimmer Body Material	: ABS Plastic
Trimming Range	: 3mm - 7mm
No of Clips Attachments	: 1 nos.(3/4/5/6/7mm)
Blade material	: Stainless Steel
Charging time	: Upto 90 mins
Run time	: Upto 120mins
Power consumption	: 2W
Product Dimension (W x D x H)	: 15.5 x 3.3 x 3.7 cm
Package Dimension (W x D x H)	: 17.8 x 4.7 x 19 cm
Net Weight	: 122g

Package Contents:

Trimmer	: 1 U
Charging Dock	: 1 U
Charging Cable	: 1 U
Cleaning Brush	: 1 U
Multistage Guide comb	: 1 U
Oil	: 1 U
QR code guide	: 1 U

Product Description:

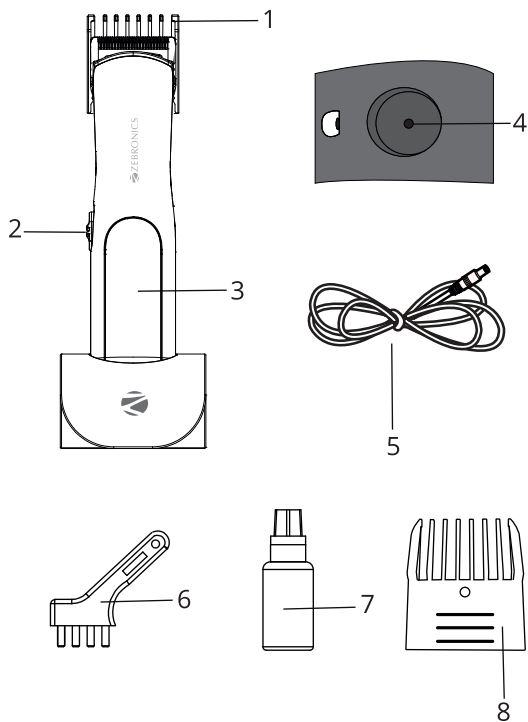

1. Trimmer Head
2. Power Slide Button
3. LED Indicator
4. Charging Dock
5. Charging Cable
6. Cleaning Brush
7. Oil
8. Multistage Guide Comb

Usage Instructions:

1. Fully charge the trimmer before every usage for better performance.
2. Add or remove the guide comb as per the levels of trimming needed.
3. Slide the power button to switch the trimmer On/Off.

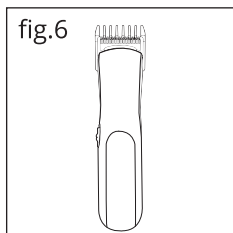
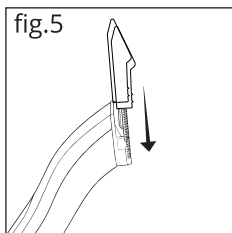
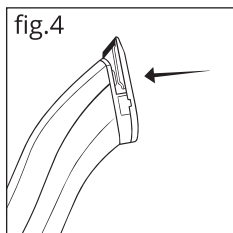
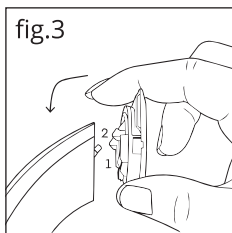
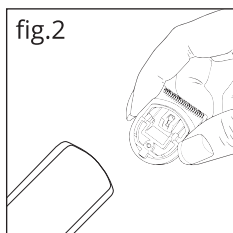
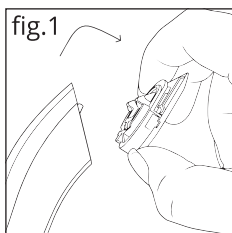

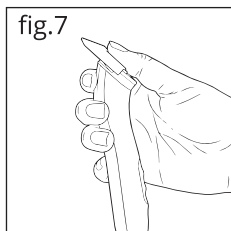

Cleaning the Trimmer after Usage:

1. Kindly remove the trimmer head from the socket.
2. Use the brush to remove the hairs from the blades of the trimmer head.
3. Also, clean the head socket of the base with the brush to clean the hair particles.
4. Avoid the usage of the water or other cleaning liquid / solvents for cleaning the trimmer.

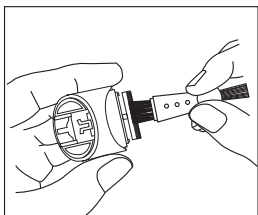
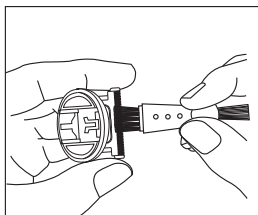

Charging Instruction:

The trimmer can be charged with the charging cable that comes with the product. Connect the Barrel connector of the charging cable to the Barrel port of a DC 5V charger and the other end to the trimmer.

Charging Instruction via Charging Dock:

Plug the trimmer into the Barrel Charging Dock and Connect the Barrel Charging Dock with the provided cable.

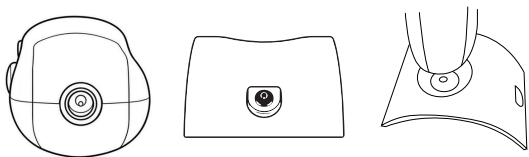

Now, connect the Barrel connector of the charging cable to the Barrel port of a DC 5V charger and the other end to the trimmer.

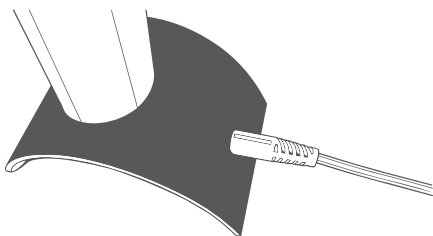

ISO 9001:2015 Certified Company
www.zebronics.com