

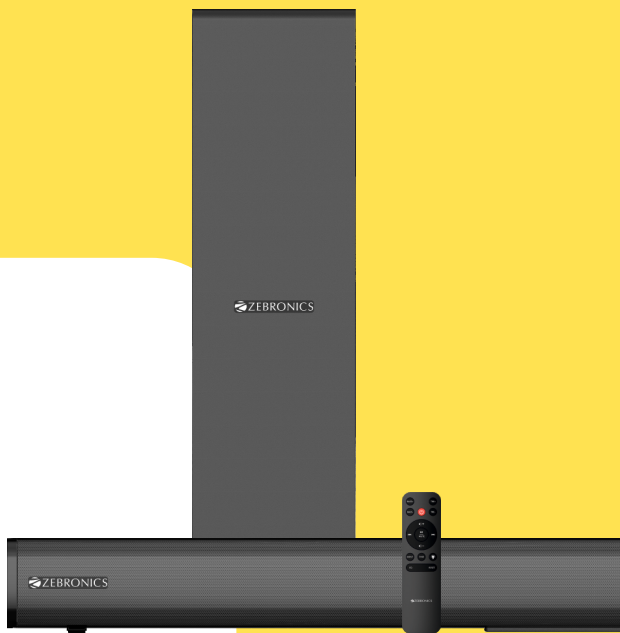

Soundbar
M
N
J
U
K
E
B
A
R
3903



User Manual

www.zebronics.com

Important Safety Instruction

Thank you for purchasing the **ZEB-JUKE BAR 3903** Soundbar. Please read this user manual carefully and keep for future reference.

Warning

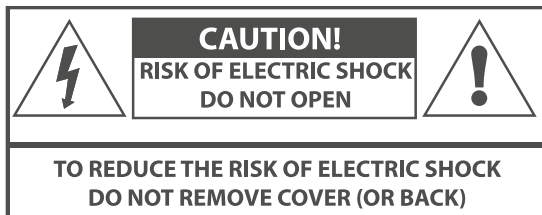

Caution:

- To reduce the risk of electric shock, do not dismantle the product and do not expose the apparatus to rain or moisture. No user-serviceable parts inside.
- Refer servicing to qualified personnel only.



The lightning flash within an equilateral triangle is intended to alert you to the presence of uninsulated dangerous voltage within the product's enclosure that may be of sufficient magnitude to constitute an electric shock to a person or persons.



Important! This symbol alerts you to read and observe important warnings and instructions on the unit or in this manual.

Notice:

1. To prevent possible hearing damage, do not listen at high volume levels for long time periods or a sudden high volume level.
2. Never use the device unsupervised! Switch off the device whenever you are not using it, even if not using it only for a short while.
3. The appliance is not intended to be operated by means of an external timer or separate remote control system.
4. If the supply cord is damaged, it must be replaced by the manufacturer, its service agent or similarly qualified persons in order to avoid a hazard.



5. Before operating this system, check the voltage of this system to see if it is identical to the voltage of your local power supply.
6. The unit should not be impeded by covering the ventilation opening with items such as newspaper, table-cloths, curtains etc. Make sure that there are at least 20 cm of space above and at least 5 cm of space on each side of the unit.
7. The apparatus must not be exposed to dripping or splashing liquid, no objects filled with liquids such as vases, should be placed on the apparatus.
8. To prevent fire or shock hazard, do not expose this equipment to direct heat, rain, moisture or dust.
9. Do not position this unit near any water sources e.g. taps, bathtubs, washing machines or swimming pools. Ensure that you place the unit on a dry, stable surface.
10. Do not place this unit close to a strong magnetic field.
11. Do not place the unit on a amplifier or receiver.
12. Do not place this unit in a damp area as the moisture will affect the life of electric components.
13. Do not attempt to clean the unit with chemical solvents as this might damage the finish. Wipe with a clean, dry or slightly damp cloth.

14. When removing the power plug from the wall outlet, always pull directly on the plug, never pull on the cord.

15. Depending on the electromagnetic waves used by a television broadcast, if a TV is turned on near this unit while it is also on, lines might appear on the LED TV. Neither this unit nor the TV is malfunctioning. If you see such lines, keep this unit well away from the TV set.

16. The mains plug is used to disconnect the device, the disconnected device should remain readily operable.

Power Source:

This soundbar is designed to operate in DC 15V \approx 1.2A.

Preparation for Use

Unpacking and Set Up

- Remove the Soundbar from the carton and remove all packing material from the Soundbar. Save the packing material, if possible, in case the Soundbar ever needs to be serviced or transported. The original carton and packing material is the only safe way to pack your Soundbar to protect it from damage in transit.
- Remove any descriptive labels or stickers on the front or top of the devices' exterior casing. Do not remove any labels or stickers from the back or bottom of the the device's exterior casing.
- Place your Soundbar on a level surface such as a table, desk or shelf, convenient to an AC outlet, out of direct sunlight, and away from sources of excess heat, dirt, dust, moisture, humidity, or vibration.
- Unwind the Line cord connecting the DC adapter and extend it to its full length.

Protect Your Furniture

This model is equipped with non-skid rubber 'feet' to prevent the product from moving when you operate the controls. These 'feet' are made from non-migrating rubber material specially formulated to avoid leaving any marks or stains on your furniture.

However certain types of oil based furniture polishes, wood preservatives, or cleaning sprays may cause the rubber 'feet' to soften, and leave marks or a rubber residue on the furniture. To prevent any damage to your furniture we strongly recommend that you purchase small self-adhesive felt pads, available at hardware stores and home improvement centers everywhere, and apply these pads to the bottom of the rubber 'feet' before you place the unit.

Product Representation



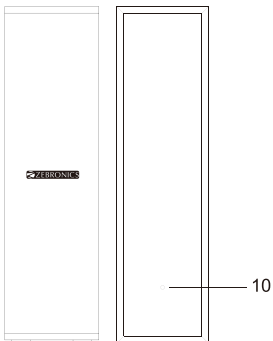
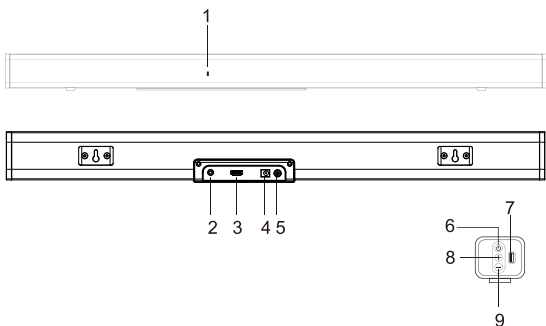



Sound Bar & Sub-Woofer

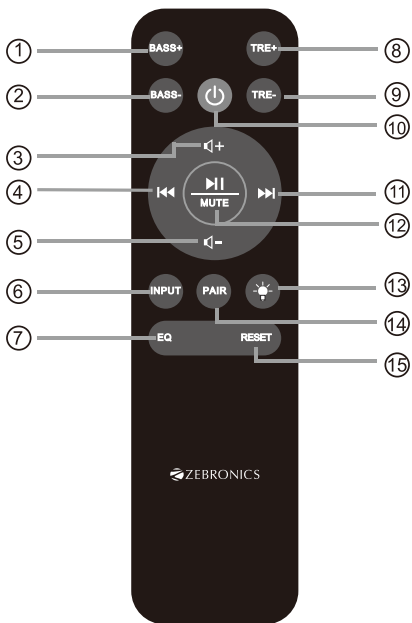

1. LED INDICATOR
2. AUX
3. TV (ARC)
4. DC IN
5. SW OUT
6. STANDBY / POWER
7. USB
8. VOL+
9. VOL-
10. SW SPEAKER

Remote Control



1. Bass +
2. Bass -
3.  : Master volume up
4.  : Previous program
(Only work under USB & BT Mode).
5.  : Master volume down
6. INPUT : Input mode (AUX / USB / TV (ARC) / BT).
7. EQ : MUSIC / MOVIE / NEWS / 3D
8. TR+ : Treble volume up.
9. TR- : Treble volume down.
10.  : Standby mode for power on/o.
11.  : Next button: Next program.
(Only work under USB and BT mode).
12.  : Play/Pause
(Only work under USB and BT mode).
MUTE : Mute mode.
13.  : Press to turn off the indicator, when there is no indicator, press to light up the indicator.
14. PAIR : Connect or disconnect to the pairing device.
(Press the button more than 2 seconds).
15. Press and hold the button more than 2 seconds to Set all functions to manufacturer defaults.

Positioning the Sound Bar

Table Placement

Place the soundbar horizontally on a solid surface such as a TV unit or shelves and align it centrally with the TV screen.

For best sound output and good airflow around the soundbar, place your soundbar and subwoofer as shown on the right.

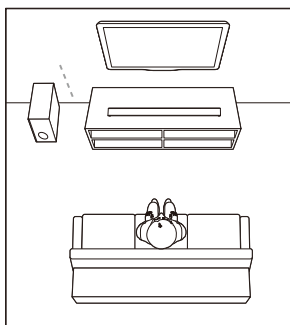

Mount on the wall

WARNING : If you don't feel confident to correctly and securely wall-mount the sound bar, Seek the assistance of an experienced person or professional.

Install the speaker on a vertical, fast, reinforced area of wall. For plaster walls, it is recommended to screw into wall studs for greater security. For optimum performance, allow at least 25mm/1" distance between the sound bar and the TV.

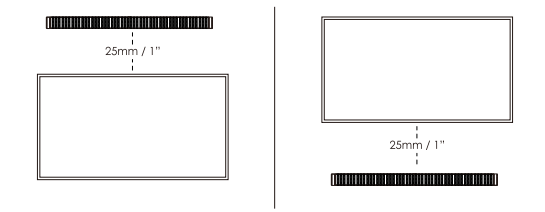

Follow below steps to mount the sound bar on the wall

1. Make 2 holes on the wall with distance same as the wall bracket on the soundbar
2. Put the plastic anchors onto the wall and secure the screws to the plastic clip, do not tighten the screws all the way make sure leave some space
3. Attached the 2 EVA pads onto the wall mount bracket. This will make sure that there is enough space between the wall and the soundbar outlet, minimum 15mm
4. Once the screws securely fastened, hang the sound bar over by inserting the screws onto the wall mount bracket

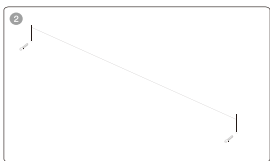
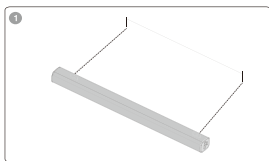

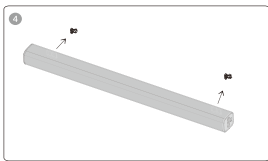

OPERATE INSTRUCTIONS

LED Indicators

LED Indicators on the soundbar appears in below color according to the input mode selected.

Blue : BT Mode

Green : AUX Mode

Pink : USB Mode

Cyan : TV (ARC) Mode

Powering On/Off

1. Plug the sound bar adapter into a wall outlet, it will automatically enter standby mode
2. Short-press the power/standby button either in soundbar or remote control to turn on the soundbar.
3. To turn off, press either the STANDBY button on remote control or soundbar or unplug from wall outlet.

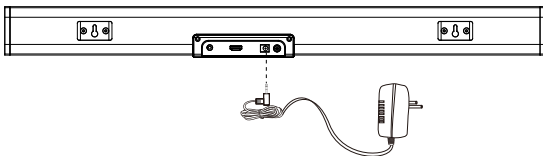

Using the Soundbar

Playing Audio via BT Connection

1. Use "Input" button on the remote to activate BT mode. A Blue LED indicator will indicate that BT mode has been selected.
2. Activate the pairing function on your phone or other compatible device and select **"ZEB-JUKE BAR 3903"**
3. When successfully paired, you will hear a tone and the LED indicator will stay on
4. The remote control includes BT mode playback controls

Notes:

- *If your pairing device switched off or manual disconnected, the sound bar will automatically enter pairing mode.*
- *If the connected device is switched off or manual disconnected, the sound bar will automatically enter pairing successfully connected device will be re-established once you re-enter wireless range (10 meters). To connect to other devices, repeat the above pairing steps.*



Playing Audio via USB Port

The soundbar automatically switches to USB input mode with Pink LED indicator when a USB flash drive is inserted.

When a USB flash drive is inserted and soundbar is powered on, press the INPUT key on remote controller to switch to USB input mode.

This mode cannot be used on the soundbar until an USB flash drive is connected.

1. Ensure that your USB flash drive contains MP3 audio file (other file types are not supported.)

2. Connect the USB flash drive to the USB port on the soundbar or by USB adapter (or your own USB extension cable connected to the USB port) and the music will be played automatically.

3. The remote control includes USB input mode playback controls.

Audio Input (Aux) Connection

1. Firstly connect the soundbar to your PC, laptop, smart-phone, TV, or other audio devices by using an AUX cable provided. Make sure that these devices have both AUX IN and AUX out terminals.

2. Then press the INPUT button on remote control to switch the soundbar to Aux mode, indicated by Green LED. And the music on your connected device will play. Playback can only be controlled on your connected device.

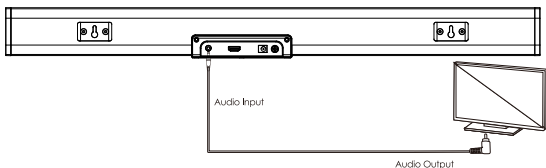

TV (ARC) Mode

1. The soundbar supports TV(ARC) with audio return channel (ARC). You can hear the TV audio through your soundbar by using a single TV(ARC) cable. But on condition that your TV is ARC compliant.
2. Using a high speed TV(ARC) cable, connect the TV(ARC) connector on the soundbar to the TV(ARC) connector on the TV. The TV(ARC) connector on the TV might be labeled differently. For details, see the user manual of your TV.
3. When TV(ARC) is connected, TV sound setting in "sound output" mode should be set as <external PCM Stereo>, in addition, digital audio output mode should be set as <automatic> or <decoded output as PCM state>. When the TV(ARC) cable is connected, the TV digital audio output is set as PCM format. Then start playing music on the TV.
4. Press "INPUT" button on the remote control to select TV(ARC) mode, indicated by Cyan LED. Different TV might be different setting, please refer to your TV User Manual.

5. Use the volume buttons to adjust the volume to your requirements.
6. You can also change the audio settings by using the relevant buttons on the remote control.

Note:

1. When connecting a device such as a TV/Set-top box/DVD/ game console with TV(ARC) cable, set the audio output mode of the device to PCM mode <digital TV(ARC) output>.
2. The TV is connected to a TV(ARC) port with sound bar. Different TVs might have different setup menus, but the operation approach is the same.
3. If needs to connect set-up box meanwhile, please firstly connect the TV(ARC) connector and paired to the soundbar. Then connect the set-top box.

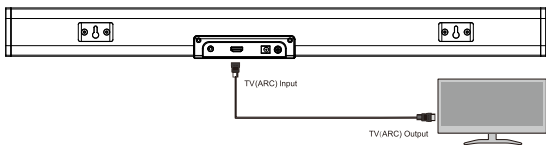

Troubleshooting

PROBLEM/TROUBLE	POSSIBLE CAUSE	SOLUTION
There is no sound output from sound bar.	Another input source is selected.	Select an appropriate input source.
	The mute function is activated.	Cancel the mute function.
	The volume of sound bar or TV/other device is adjusted too low.	Increase the volume level on sound bar or by remote control or on TV.
	The power cable of the unit is not connected properly.	Make sure that the power cable of the unit is connected to an AC wall outlet securely.
	Input jacks on a playback device are connected.	Connect the input jack on the sound bar and the output jack on the playback device.
	Signals that the sound bar cannot playback when being input.	When sound bar and TV or other devices are connected by an audio cable through TV (ARC) port output, Select the correct audio input and output. Make sure the digital audio output setting on the playback device to PCM format. Since the output format of our sound bar is PCM, if it is used, the decoding format of TV or other devices will be adjusted to PCM state.
The sound is distorted or echoed.	TV volume is not muted.	If you play audio from TV through the sound bar, make sure that the TV is muted.
The volume decreases when the unit is turned on.	The automatic volume adjustment function is activated. To prevent excessive loudness, the unit automatically controls its volume within a certain level when the unit is turned on.	Turn up the volume as required.
Noise is heard.	The sound bar is too close to another digital or high-frequency device.	Move those devices away from the sound bar.
The unit cannot be operated by using the remote control.	The unit is out of the operating range.	Use the remote control within the operating range.
	The batteries are weak.	Replace with new batteries.
	The remote control sensor of the sound bar is exposed to direct sunlight or strong lighting.	Adjust the lighting angle or reposition the sound bar. Make sure our product cannot be used in sunlight.
The TV cannot be operated by using the TV's remote control.	The unit is blocking the TV's remote control sensor.	Position the unit so that it does not obstruct the TV's remote control sensor.
A device cannot connect the sound bar or the unit cannot be connected to a BT device.	BT function of the device is not activated, not paired or connected correctly.	Restart the sound bar and try pairing again. You have not enabled the BT function of the device; see the user manual of the device on how to enable the function and correctly connected the device. The sound bar is already connected with another BT device. Disconnect the connected device, and then try again.
	BT is not selected as the input source.	Select BT as the input source.
	The unit is connected to a different BT device.	Un-pair the BT device that is currently connected and pair with the desired BT device.
	The unit is too far away from the BT device.	Move the BT device closer to this unit.
	A device emitting electromagnetic waves (such as a microwave oven, a wireless device and so on) may be placed nearby.	Do not use this unit near devices that emit electromagnetic waves.
	The BT device that you are using may not support the protocol.	Use a BT device that supports the protocol.
	The connection profile registered in the BT device may not be functioning correctly for some reason.	Delete the connection profile in the BT device and then connect the BT device to this unit.
Sound quality of audio play from a connected BT device is poor and connection is not stable.	The BT reception is poor.	Move the device closer to the sound bar, or remove any obstacle between the device and the sound bar.
No sound can be heard or sound breaks (BT mode)	The volume on the BT device may be too low.	Raise the volume on the BT device.
	BT is not selected as the input source.	Select the BT as the input source.
	Playback on the device has not been performed.	Perform playback on the device.
	The sound output on the BT device may not be set to this unit.	Select this unit as the output device on the BT device.
	The connection to the BT device was cut off.	Connect with the BT device one more time.
	The unit may be too far away from the BT device.	Move the BT device near this unit.

PROBLEM/TROUBLE	POSSIBLE CAUSE	SOLUTION
	A device emitting electromagnetic waves (such as a microwave oven, a wireless device and so on) may be placed nearby.	Do not use this unit near device that emit electromagnetic waves.
There is no sound from sound bar - TV (ARC) Mode	Incorrect HDMI cable is used causing no signal to be sent to soundbar. Incorrect input mode is selected.	1. Make sure that the user connected TV and sound bar by a 19-core HD ARC cable. 2. The sound bar and TV are connected through TV (ARC) port output; make sure that the TV is ARC compliant. 3. Set the TV to HDMI ARC (CEC). Set the audio output mode of TV to PCM format. (Or refer to your TV user manual)
There is no sound from sound bar (USB mode)	USB file type is not support & Sound bar doesn't switch to USB input mode automatically when USB is inserted.	Make sure that USB flash drive contains MP3 files because other file types are not supported. Switch the input mode once again, then playback again.

Features:

BT v5.1 | TV (ARC) | USB | AUX

11.43cm Subwoofer

Soundbar with Dual Drivers

Virtual 5.1

Wall Mountable

LED Indicator

Volume/Media Control

Remote Control

Specifications

Output Power (RMS)

Subwoofer : 50W

Soundbar : 30W (15W + 15W)

Total : 80W

Driver Size

Subwoofer : 11.43 cm x 1

Soundbar : 5.08 cm x 2

Impedance

Subwoofer : 4Ω

Soundbar : 8Ω

Frequency Response : 65Hz-20kHz

S/N Ratio : ≥66dB

Separation	: ≥30dB
File Format Support	: MP3 (USB)
Line Input	: 3.5mm, TV (ARC)
Max Supported	
Memory Size (USB)	: 32 GB
BT Name	: ZEB-JUKE BAR 3903
BT Version	: 5.1
Product Dimension (W x D x H)	
Subwoofer	: 10 x 18.5 x 35.5 cm
Sound bar	: 70 x 6.3 x 6.3 cm
Net. Weight	
Subwoofer	: 1.8 kg
Soundbar	: 1.25 kg
Total	: 3.05 kg

Package Content

Sound Bar	: 1 U
Subwoofer	: 1 U
Remote Control	: 1 U
Input Cable	: 1 U
Wall Mount Fasteners	: 1 U
Power Adapter	: 1 U
QR Code Guide	: 1 U

ISO 9001:2015 Certified Company

www.zebronics.com

