

# ZEBRONICS

Soundbar  
**METN** JUKE BAR  
**9530WS**  
PRO DOLBY 5.1

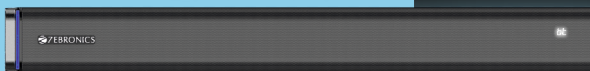
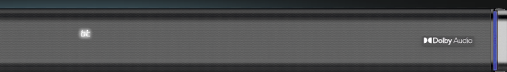

## User Manual

[www.zebronics.com](http://www.zebronics.com)

## Important Safety Instruction

Thank you for purchasing the **ZEB-JUKE BAR 9530WS DOLBY 5.1** Soundbar. Please read this user manual carefully and keep for future reference.

### Warning



#### Caution:

- To reduce the risk of electric shock, do not dismantle the product and do not expose the device to rain or moisture. No user-serviceable parts inside.
- Refer servicing to qualified personnel only.



The lightning flash within an equilateral triangle is intended to alert you to the presence of uninsulated dangerous voltage within the product's enclosure that may be of sufficient magnitude to constitute an electric shock to a person or persons.



Important! This symbol alerts you to read and observe important warnings and instructions on the unit or in this manual.

**Notice:**

This device is not intended for use by persons (including children) with reduced physical sensory or mental capabilities, or lack of experience and knowledge, unless they have been given supervision or instruction concerning use of the device by a person responsible for their safety.

Children should be supervised to ensure that they do not play with the device.

1. To prevent possible hearing damage, do not listen at high volume levels for long time periods or a sudden high volume level.



2. Never use the device unsupervised! Switch off the device whenever you are not using it, even if not using it only for a short while.
3. The device is not intended to be operated by means of an external timer or separate remote control system.
4. If the supply cord is damaged, it must be replaced by the manufacturer, its service agent or similarly qualified persons in order to avoid a hazard.
5. Before operating this system, check the voltage of this system to see if it is identical to the voltage of your local power supply.
6. The unit should not be impeded by covering the ventilation opening with items such as newspaper, table-cloths, curtains etc. Make sure that there are at least 20 cm of space above and at least 5 cm of space on each side of the unit.
7. The device must not be exposed to dripping or splashing liquid, no objects filled with liquids such as vases, should be placed on the device.
8. To prevent fire or shock hazard, do not expose this equipment to direct heat, rain, moisture or dust.
9. Do not position this unit near any water sources e.g. taps, bathtubs, washing machines or swimming pools. Ensure that you place the unit on a dry, stable surface.
10. Do not place this unit close to a strong magnetic field.

11. Do not place the unit on a amplifier or receiver.

12. Do not place this unit in a damp area as the moisture will affect the life of electric components.

13. Do not attempt to clean the unit with chemical solvents as this might damage the finish. Wipe with a clean, dry or slightly damp cloth.

14. When removing the power plug from the power socket, always pull directly on the plug, never pull on the cord.

15. Depending on the electromagnetic waves used by a television broadcast, if a TV is turned on near this unit while it is also on, lines might appear on the LED TV. Neither this unit nor the TV is malfunctioning. If you see such lines, keep this unit well away from the TV set.

16. The mains plug is used to disconnect the device, the disconnected device should remain readily operable.

### **Important Safety Instructions**

1. Read these instructions. Keep these instructions. Follow all instructions. Heed all warnings.

2. Do not use this device near water.

3. Clean only with dry cloth.

4. Do not block any ventilation openings. Install in accordance with the manufacturer's

instructions.

5. Do not install near any heat sources such as radiators, heaters, stoves, or other device (including amplifiers) that produce heat.

6. Protect the power cord from being walked on or pinched particularly at plugs, convenience receptacles or at the point where they exit from the device.

7. Only use attachments/accessories specified by the manufacturer.

8. Unplug this device during lightning storms or when unused for long periods of time.

9. Refer all servicing to qualified service personal. Servicing is required when the device has been damage in any way, for example, when the power-supply cord or plug is damaged, liquid has been spilled or objects have fallen into the device, the device has been exposed to rain or moisture, does not operate normally, or has been dropped.

10. The AC plug is used to disconnect the device, the disconnected device should remain readily operable. In order to disconnect the device from the AC power completely, the AC plug must be removed from the AC power socket completely.

### **Power Source:**

This soundbar is designed to operate in AC 220-240V 50/60Hz.

## Preparation for Use

### Unpacking and Set Up

- Remove the Sound bar from the carton and remove all packing material from the Sound bar. Save the packing material, if possible, in case the Sound bar ever needs to be serviced or transported.
- The original carton and packing material is the only safe way to pack your Sound bar to protect it from damage in transit.
- Remove any descriptive labels or stickers on the front or top of the cabinet. Do not remove any labels or stickers from the back or bottom of the cabinet.
- Place your Sound bar on a level surface such as a table, desk or shelf, convenient to an AC power socket, out of direct sunlight, and away from sources of excess heat, dirt, dust, moisture, humidity, or vibration.
- Unwind the Line cord connecting the AC adapter and extend it to its full length.

### Protect Your Furniture

This model is equipped with non-skid rubber 'feet' to prevent the product from moving when you operate the controls. These 'feet' are made from non-migrating rubber material specially formulated to avoid leaving any marks or stains on your furniture. However certain types of oil based furniture

polishes, wood preservatives, or cleaning sprays may cause the rubber 'feet' to soften, and leave marks or a rubber residue on the furniture. To prevent any damage to your furniture we strongly recommend that you purchase small self-adhesive felt pads, available at hardware stores and home improvement center everywhere, and apply these pads to the bottom of the rubber 'feet' before you place the unit.

### **Important Notes**

- Safety and operating instruction manual should be retained for future reference.
- The device should not be exposed to dripping, splashing or placed in a humid atmosphere such as a bathroom.
- Do not install the product in the following areas:
  - Places exposed to direct sunlight or close to radiators.
  - On top of other stereo equipment that radiate too much heat -Blocking ventilation or in a dusty area.
  - Areas where there is constant vibration.
  - Humid or moist places.
  - Do not place near candles or other flames.
  - Operate the product only as instructed in this manual.
  - Before turning on the power for the first



time, make sure the sound bar is plugged to power socket.

- For safety reasons, do not remove any covers or attempt to gain access to the inside of the product. Refer any servicing to qualified personnel.
- Do not attempt to remove any screws, or open the casing of the unit; there are no user serviceable parts inside. Refer all servicing to qualified service personnel.

# Product Representation

## Sound Bar

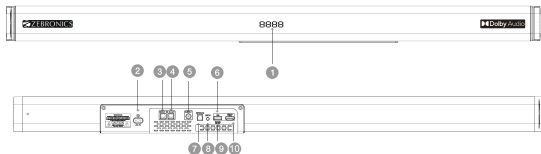



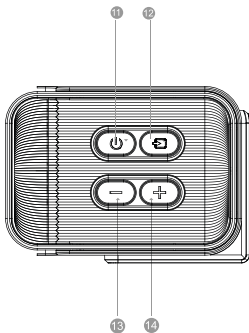

1. LED DISPLAY
2. AC IN
3. SR OUT
4. SL OUT
5. SW OUT
6. USB
7. OPTICAL
8. LINE IN(AUX)
9. FOR UPDATE
10. HDMI (ARC)
11. POWER/STAND BY
12. INPUT MODE
13. VOL -
14. VOL +

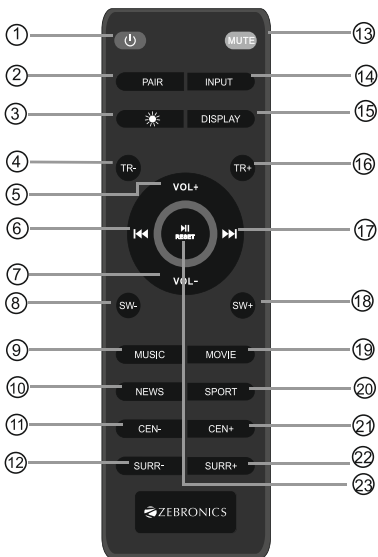

# Remote Control



1.  : Standby mode for power on/off.
2. PAIR : Connect or disconnect to the pairing device.  
(Press the button more than 2 seconds).
3.  : Short Press the light effect mode button to switch the light effectiveness.
4. TR- : Treble Volume Decrease.
5. Volume+ : Master Volume Increase
6.  Pre Button : Previous program only work under USB & BT Mode).
7. Volume- : Master Volume Decrease.
8. SW : Subwoofer Channel Volume Decrease.
9. MUSIC : Select the Music EQ effect.
10. NEWS : Select the News EQ effect.
11. CEN- : Center Channel Volume Decrease.
12. SURR- : Surround Channel Volume Decrease.
13. MUTE : Mute Mode.
14. INPUT : Input Mode (AUX/USB/ARC/OPT/BT).
15. DISPLAY : LED Display on/off, Only work under power on.
16. TR+ : Treble Volume Increase.
17.  Next Button : Next Program. (Only work under USB and BT mode).
18. SW+ : Subwoofer Channel Volume Increase.
19. MOVIE : Select the Movie EQ effect.
20. SPORT : Select the Sport EQ effect.
21. CEN+ : Center Channel Volume Increase.
22. SURR+ : Surround Channel Volume Increase.
23.  : Play/Pause Only work under USB and BT mode).

Reset: press and hold the button more than 3 sec. to set all function to manufacturer defaults

## Positioning the Sound Bar

### Place on a flat Surface

Place the sound bar horizontally on a flat surface such as a TV unit or shelves and align it centrally with the TV screen. Allow some space between the speaker and the wall. Don't place inside a cabinet or on a walled shelf. Follow this guidance for best sound output and good airflow around the sound bar.

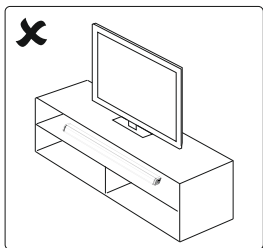
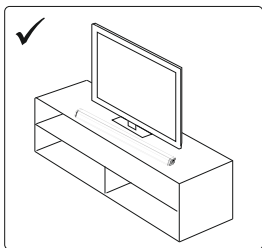

### Mount on the wall

**WARNING :** If you don't feel confident to correctly and securely wall-mount the sound bar, Seek the assistance of an experienced person or professional.

Install the speaker on a vertical, fast, reinforced area of wall. For plaster walls, it is recommended to screw into wall studs for greater security. For optimum performance, allow at least 25mm/1" distance between the sound bar and the TV.

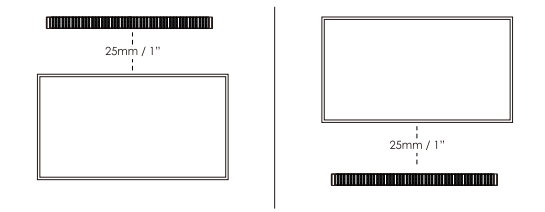

## Follow below steps to mount the sound bar on the wall

1. Make 2 holes on the wall with distance same as the wall bracket on the soundbar
2. Put the plastic anchors onto the wall and secure the screws to the plastic clip, do not tighten the screws all the way make sure leave some space.
3. Once the screws securely fastened, hang the sound bar over by inserting the screws onto the wall mount bracket

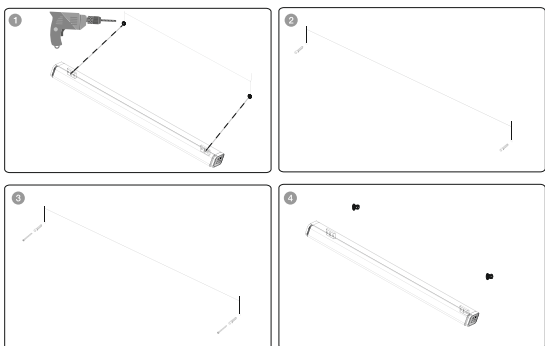

## Follow below steps to mount the surround speaker on the wall

1. Make 2 holes on the wall with distance of two surround speakers you needed.
2. Put the plastic anchors onto the wall and secure the screws to the plastic clip, do not tighten the screws all the way make sure leave some space.
3. Attached the 2 EVA pads onto the wall mount bracket. This will make sure that there is enough space between the wall and the surround speakers outlet, minimum 15mm.
4. Once the screws securely fastened, hang the surround speaker over by inserting the screws onto the wall mount bracket.

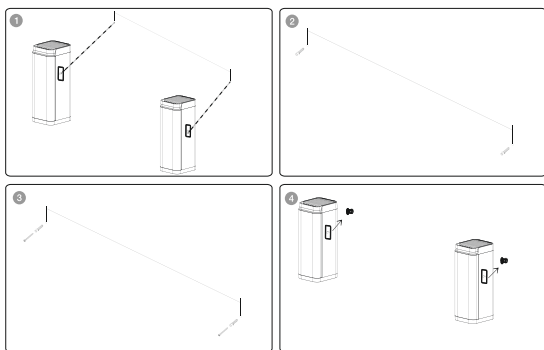

## OPERATE INSTRUCTIONS

### Setting the Soundbar

1. Plug in the power cord and the display will light up (Standby mode)
2. Switch on the sound bar by pressing "STANDBY" button on sound bar or on remote controller. After switching on, the default input mode will appear on display.
3. Input modes can be changed by pressing the "INPUT" button on sound bar or on remote controller.
4. Below are input mode names appearing in the soundbar display:

bt - BT Pairing mode

RUX - AUX mode

OPT - Optical mode

Hd - ARC mode

U**s**b - USB mode

### Breathing LED Light Color Selection

1. When you connect with the soundbar to the power ,the screen goes into standby mode. Press the Power/Standby key and the soundbar will enter the mode selection.The LED light sources on both sides light up. Press the INPUT key to select the mode you want.
2. Short press the breathing LED light button on the remote control and choose the colour to you like.

*Note : The light color adjustment can only be in the remote control.*



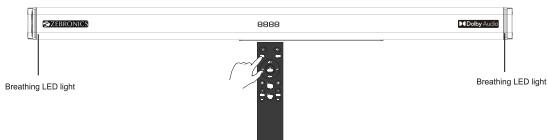

	<b>MODE 1:</b> Blue steady on / Pink on / Red steady on / Orange steady on / Green steady on / Light white steady on / Dark white steady on
	<b>MODE 2:</b> Blue breathing / Purple breathing / Red breathing / Orange breathing / Green breathing / Pale white breathing / Deep white breathing
	<b>MODE 3:</b> Monochromatic cyclic variation
	<b>MODE 4:</b> Respiratory circulation

## Powering On/Off

5. Plug the power cord of sound bar into a power socket, it will automatically enter standby mode.

6. Short-press the "**STANDBY**" button on sound bar or on remote controller to turn on the sound bar.

7. To turn off, press and hold the "**STANDBY**" button for 2 seconds, then unplug from power socket.

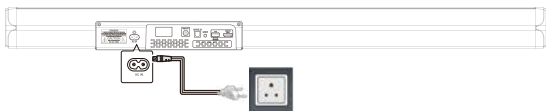

## Playing Audio via BT Connection

1 Turn on the sound bar and then short-press the “**INPUT**” button on sound bar or remote controller to switch it to BT mode and LED display on the sound bar will flicker in the Bluetooth pairing mode.

2. Activate the pairing function on your phone or other compatible device and select “**ZEB-JUKE BAR 9530WS PRO DOLBY**” by BT connection.

3. When successfully paired, you will hear a tone and LED display will turn on “**bt**” and stop flickering. Then music that you selected can be played on the sound bar.

4. The remote controller includes BT mode playback controls.

### Notes:

- If your pairing device switched off or manual disconnected, the sound bar will automatically enter pairing mode.

- If the connected device is switched off or manual disconnected, the sound bar will automatically enter pairing successfully connected device will be re-established once you re-enter wireless range(10 meters).

- There is no automatic shutdown in pairing mode. The sound bar will remain in pairing mode even if no device is paired, so switch off if not in use



## Playing Audio via USB Port

The sound bar automatically switches to USB input mode with the LED display “**Usb**” when a USB flash drive is inserted (this mode isn't selectable on the sound bar or remote control unless a USB flash drive is connected).

1. Ensure that your USB flash drive contains MP3 audio files (other file types not supported)
2. Connect the USB flash drive to the USB port on the sound bar (or your own USB extension cable connected to the USB port); music will automatically play
3. The remote control includes USB input mode playback controls



# Using the Soundbar

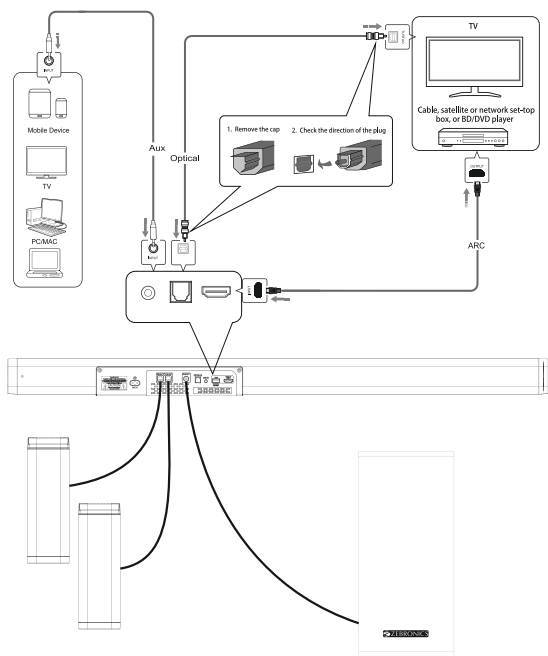

## **Audio input (Aux) Connection**

1. Firstly connect the soundbar to your PC, laptop, smart-phone, TV, or other audio devices by using an AUX cable provided. Make sure that these devices have both AUX IN and AUX OUT terminals.
2. Then press the INPUT button on remote control to switch the soundbar to Aux mode, once the soundbar is connected in Aux mode, the screen will display "**AU**". And the music on your connected device will play. Playback can only be controlled on your connected device.

***Note:** For some computers, you may need to access the audio control panel to manually set the soundbar as shown steps on above.*

## **HDMI (ARC) Mode**

1. The soundbar supports HDMI (ARC) with audio return channel (ARC). You can hear the TV audio through your soundbar by using a single HDMI (ARC) cable. But on condition that your TV is ARC compatible
2. Using a high speed HDMI (ARC) cable, connect the HDMI (ARC) connector on the soundbar to the HDMI (ARC) connector on the TV. The HDMI (ARC) connector on the TV might be labeled differently. For details, see the user manual of your TV.
3. When HDMI (ARC) is connected, TV sound setting in "sound output" mode should be set as <external Dolby or Auto mode>, in addition,

digital audio output mode should be set as <automatic> or <decoded output as Dolby>. When the HDMI (ARC) cable is connected, the TV digital audio output is set as Dolby or Auto mode. Then start playing music on the TV.

4. Press "INPUT" button on the remote control to select **Hd** - HDMI (ARC) mode. Different TV might be different setting, please refer to your TV User Manual.

5. Use the volume buttons to adjust the volume to your requirements.

6. You can also change the audio settings by using the relevant buttons on the remote control.

**Note:**

*1. When connecting a device such as a TV/Set-top box/DVD/game console with HDMI (ARC) cable, set the audio output mode of the device to Dolby or Auto mode <digital HDMI (ARC) output>.*

*2. The TV is connected to a HDMI (ARC) port with sound bar. Different TVs might have different setup menus, but the operation approach is the same.*

*3. If needs to connect set-up box meanwhile, please firstly connect the HDMI (ARC) connector and paired to the soundbar. Then connect the set-top box.*

## Optical Mode

Check the direction of the plug. Connect the soundbar and TV with the optical cable.

Use this mode to play music from a TV with optical digital output on the sound bar. In TV sound settings, select the soundbar optical connection (output for audio). When the optical cable is connected, the TV audio output is set to Dolby or Auto mode.

The TV must have an optical digital output. Use the optical cable to make the connection as follows:

1. Connect the optical cable to the optical digital output of your TV.
2. Connect the optical cable to the optical digital input of your soundbar.
3. Switch on the TV set and the soundbar. Set the connected TV to "Dolby or Auto mode".
4. Start playing on the TV.
5. Press "INPUT" button on the remote control or "STANDBY" button on the soundbar to select **Opt- OPTICAL** mode.
6. Use the volume buttons to adjust the volume to your requirements.
7. You can also change the audio settings by using the relevant buttons on the remote control.

**Note:**

1. When connecting a device such as a TV/Set-top box/ DVD/ game console with optical cable, set the audio output mode of the device to Dolby or Auto mode (digital optical output).
2. Do not bend the optical cable, otherwise the cable inside will be damaged.

**Features:**

Multi Connectivity (BT v5.0 | HDMI (ARC) | Optical IN | USB | AUX)  
16.51cm Subwoofer  
Remote control  
Wall Mountable  
LED Display  
Dolby Audio  
Volume/Media Control

**Specifications**

## Output Power

Subwoofer	: 160 watts
Soundbar	: 140 watts
Satellites	: 50 watts x 2
Total	: 400 watts

## Driver Size

Subwoofer	: 16.51cm x 1
Soundbar	: [5.4 x 9.5 cm] x 3
Satellites	: 5.71cm x 2

## Impedance

Subwoofer	: 4Ω
Soundbar	: 8Ω
Satellites	: 8Ω

Frequency response : 20Hz-20kHz



S/N Ratio	: ≥65dB
Separation	: ≥40dB
File format support	: MP3 (USB)
Line input	: AUX, Optical IN, HDMI (ARC)
Max Supported Memory Size (USB)	: 32GB
BT name	: ZEB-JUKE BAR 9530WS PRO DOLBY
BT Version	: v5.0
Product Dimension (W x D x H)	
Subwoofer	: 19 x 30.6 x 36.8 cm
Sound bar	: 96 x 9.5 x 7 cm
Satellites	: 6.3 x 9 x 19 cm
Net. Weight	
Subwoofer	: 4.3 kg
Sound bar	: 2.15 kg
Satellites	: 450g x 2
Total	: 7.35 kg

# Troubleshooting

PROBLEM/TROUBLE	POSSIBLE CAUSE	SOLUTION
There is no sound output from sound bar.	Another input source is selected.	Select an appropriate input source.
	The mute function is activated.	Cancel the mute function.
	The volume of sound bar or TV/other device is adjusted too low.	Increase the volume level on sound bar or by remote control or on TV.
	The power cable of the unit is not connected properly.	Make sure that the power cable of the unit is connected to an AC wall outlet securely.
	Input jacks on a playback device are connected.	Connect the input jack on the sound bar and the output jack on the playback device.
	Signals that the sound bar cannot playback when being input.	When sound bar and TV or other devices are connected by an audio cable through TV (ARC) port output, Select the correct audio input and output. Make sure the digital audio output setting on the playback device to PCM format. Since the output format of our sound bar is PCM, if it is used, the decoding format of TV or other devices will be adjusted to PCM state.
The sound is distorted or echoed.	TV volume is not muted.	If you play audio from TV through the sound bar, make sure that the TV is muted.
The volume decreases when the unit is turned on.	The automatic volume adjustment function is activated. To prevent excessive loudness, the unit automatically controls its volume within a certain level when the unit is turned on.	Turn up the volume as required.
Noise is heard.	The sound bar is too close to another digital or high-frequency device.	Move those devices away from the sound bar.
The unit cannot be operated by using the remote control.	The unit is out of the operating range.	Use the remote control within the operating range.
	The batteries are weak.	Replace with new batteries.
	The remote control sensor of the sound bar is exposed to direct sunlight or strong lighting.	Adjust the lighting angle or reposition the sound bar. Make sure our product cannot be used in sunlight.
The TV cannot be operated by using the TV's remote control.	The unit is blocking the TV's remote control sensor.	Position the unit so that it does not obstruct the TV's remote control sensor.
A device cannot connect the sound bar or the unit cannot be connected to a Bluetooth device.	Bluetooth function of the device is not activated, not paired or connected correctly.	Restart the sound bar and try pairing again. You have not enabled the Bluetooth function of the device; see the user manual of the device on how to enable the function and correctly connected the device. The sound bar is already connected with another Bluetooth device. Disconnect the connected device, and then try again.
	Bluetooth is not selected as the input source.	Select Bluetooth as the input source.
	The unit is connected to a different Bluetooth device.	Un-pair the Bluetooth device that is currently connected and pair with the desired Bluetooth device.
	The unit is too far away from the Bluetooth device.	Move the Bluetooth device closer to this unit.
	A device emitting electromagnetic waves (such as a microwave oven, a wireless device and so on) may be placed nearby.	Do not use this unit near devices that emit electromagnetic waves.
	The Bluetooth device that you are using may not support the protocol.	Use a Bluetooth device that supports the protocol.
	The connection profile registered in the Bluetooth device may not be functioning correctly for some reason.	Delete the connection profile in the Bluetooth device and then connect the Bluetooth device to this unit.
Sound quality of audio play from a connected Bluetooth device is poor and connection is not stable.	The Bluetooth reception is poor.	Move the device closer to the sound bar, or remove any obstacle between the device and the sound bar.
No sound can be heard or sound breaks (Bluetooth mode)	The volume on the Bluetooth device may be too low.	Raise the volume on the Bluetooth device.
	Bluetooth is not selected as the input source.	Select the Bluetooth as the input source.
	Playback on the device has not been performed.	Perform playback on the device.
	The sound output on the Bluetooth device may not be set to this unit.	Select this unit as the output device on the Bluetooth device.
	The connection to the Bluetooth device was cut off.	Connect with the Bluetooth device one more time.
	The unit may be too far away from the Bluetooth device.	Move the Bluetooth device near this unit.

PROBLEM/TROUBLE	POSSIBLE CAUSE	SOLUTION
	A device emitting electromagnetic waves (such as a microwave oven, a wireless device and so on) may be placed nearby.	Do not use this unit near device that emit electromagnetic waves.
There is no sound from sound bar - HDMI TV (ARC) Mode	Incorrect HDMI cable is used causing no signal to be sent to soundbar. Incorrect input mode is selected.	1. Make sure that the user connected TV and sound bar by a 19-core HD ARC cable. 2. The sound bar and TV are connected through TV (ARC) port output; make sure that the TV is ARC compliant. 3. Set the TV to HDMI ARC (CEC). Set the audio output mode of TV to PCM format. (Or refer to your TV user manual)
There is no sound from sound bar (OPTICAL Mode)	OPTICAL cable might be damaged and no signal is received by the soundbar due to a failed connection and incorrect operation mode selected.	1. Replace the OPTICAL cable with a new one to connect. 2. Set your TV audio output to PCM format. (Pls refer to your TV user manual)
There is no sound from sound bar (USB mode)	USB file type is not support & Sound bar doesn't switch to USB input mode automatically when USB is inserted.	Make sure that USB flash drive contains MP3 files because other file types are not supported. Switch the input mode once again, then playback again.
Disconnected between subwoofer and sound bar	Connection is not correct between subwoofer and sound bar	1. Turn off sound bar and subwoofer by removing the AC plug from the socket. 2. Make sure that sound bar and subwoofer are connected to the electricity power at the same time , and switch on sound bar and subwoofer again. 3. Press and hold the subwoofer's rear plate WPS button to reset the connection, so that the sound bar and subwoofer can be reconnected again.

**ISO 9001:2015 Certified Company**  
**www.zebronics.com**

