



Soundbar
MBN **JUKE BAR**
9775



User Manual

www.zebronics.com

Important Safety Instruction

Thank you for purchasing the **ZEB-JUKE BAR 9775** Soundbar. Please read this user manual carefully and keep for future reference.

Warning

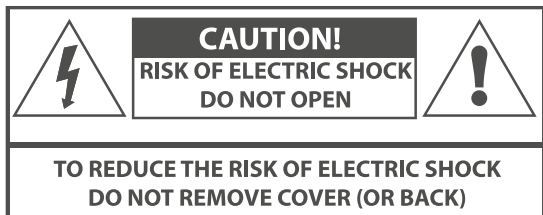

Caution:

- To reduce the risk of electric shock, do not dismantle the product and do not expose the unit to rain or moisture. No user-serviceable parts inside.
- Refer servicing to qualified personnel only.



The lightning flash within an equilateral triangle is intended to alert you to the presence of uninsulated dangerous voltage within the product's enclosure that may be of sufficient magnitude to constitute an electric shock to a person or persons.



Important! This symbol alerts you to read and observe important warnings and instructions on the unit or in this manual.

Notice:

1. To prevent possible hearing damage, do not listen at high volume levels for long time periods or a sudden high volume level.
2. Never use the device unsupervised! Switch off the device whenever you are not using it, even if not using it only for a short while.
3. The unit is not intended to be operated by means of an external timer or separate remote control system.
4. If the supply cord is damaged, it must be replaced by the manufacturer, its service agent or similarly qualified persons in order to avoid a hazard.



5. Before operating this system, check the voltage of this system to see if it is identical to the voltage of your local power supply.
6. The unit should not be impeded by covering the ventilation opening with items such as newspaper, table-cloths, curtains etc. Make sure that there are at least 20 cm of space above and at least 5 cm of space on each side of the unit.
7. The unit must not be exposed to dripping or splashing liquid, no objects filled with liquids such as vases, should be placed on the unit.
8. To prevent fire or shock hazard, do not expose this equipment to direct heat, rain, moisture or dust.
9. Do not position this unit near any water sources e.g. taps, bathtubs, washing machines or swimming pools. Ensure that you place the unit on a dry, stable surface.
10. Do not place this soundbar close to a strong magnetic field.
11. Do not place the soundbar on a amplifier or receiver.
12. Do not place this soundbar in a damp area as the moisture will affect the life of electric components.
13. Do not attempt to clean the soundbar with chemical solvents as this might damage the finish. Wipe with a clean, dry or slightly damp cloth.
14. When removing the power plug from the

power socket, always pull directly on the plug, never pull on the cord.

15. Depending on the electromagnetic waves used by a television broadcast, if a TV is turned on near this unit while it is also on, lines might appear on the LED TV. Neither this unit nor the TV is malfunctioning. If you see such lines, keep this unit well away from the TV set.

16. The mains plug is used to disconnect the device, the disconnected device should remain readily operable.

Preparation for Use

Unpacking and Set Up

- Remove the Sound bar from the carton and remove all packing material from the Sound bar. Save the packing material, if possible, in case the Sound bar ever needs to be serviced or transported.
- The original carton and packing material is the only safe way to pack your Sound bar to protect it from damage in transit.
- Remove any descriptive labels or stickers on the front or top of the cabinet. Do not remove any labels or stickers from the back or bottom of the cabinet.
- Place your Sound bar on a level surface such as a table, desk or shelf, convenient to an AC power socket, out of direct sunlight, and away from sources of excess heat, dirt, dust, moisture, humidity, or vibration.
- Unwind the Line cord connecting the AC adapter and extend it to its full length.

Protect Your Furniture

This model is equipped with non-skid rubber 'feet' to prevent the product from moving when you operate the controls. These 'feet' are made from non-migrating rubber material specially formulated to avoid leaving any marks or stains on your furniture. However certain types of oil based furniture

polishes, wood preservatives, or cleaning sprays may cause the rubber 'feet' to soften, and leave marks or a rubber residue on the furniture. To prevent any damage to your furniture we strongly recommend that you purchase small self-adhesive felt pads, available at hardware stores and home improvement center everywhere, and apply these pads to the bottom of the rubber 'feet' before you place the unit.

Power Source:

This soundbar is designed to operate in AC 220-240V 50/60Hz.

Product Representation

Sound Bar

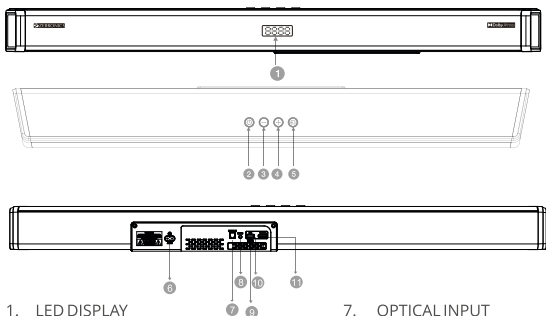

- | | |
|----------------|--------------------|
| 1. LED DISPLAY | 7. OPTICAL INPUT |
| 2. STANDBY | 8. AUX INPUT |
| 3. VOLUME - | 9. FOR UPDATE ONLY |
| 4. VOLUME + | 10. USB |
| 5. INPUT | 11. TV (eARC) |
| 6. AC IN | |

Sub-Woofer

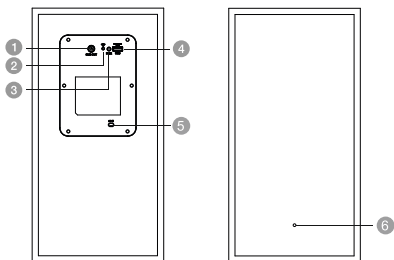

1. SUB OUT
2. LED indicator: It indicates pairing between the soundbar and the subwoofer.
3. PAIR: It automatically pairs the soundbar with subwoofer.
4. USB Port (CAN'T PLAY MP3 MUSIC, FOR SOFTWARE UPGRADE ONLY)
5. AC IN
6. SUB OUT

Rear Satellite

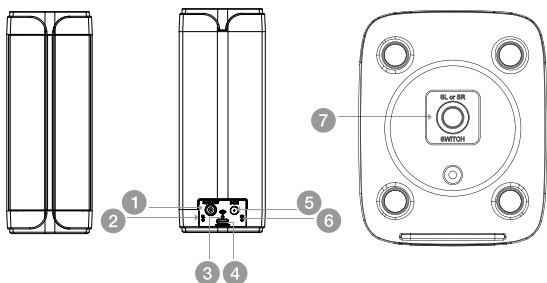



1. Wireless Surround SL or SR out (wireless surround Channel is fixed, when end user's power socket position isn't matched, please press switch button from bottom of surround speaker to exchange channel position.)
2. Wireless surround SL channel LED light
3. LED indicator: Indicates the pairing between soundbar and wireless surround speaker
4. FOR UPDATE ONLY
5. DC IN
6. Wireless surround SR channel LED light
7. Press in short time for exchange L/R channel: Surround channel (SL OR SR) switch button (wireless surround Channel is fixed, when end user's power socket position isn't matched, please press switch button from bottom of surround speaker to exchange channel position).

Press in long time for surround speaker pair with soundbar.

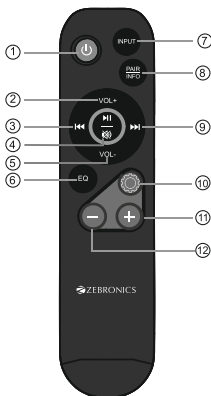
Remote Control



1. : Standby mode for power on/off.
2. Volume+ : Master Volume Increase
3. Pre button : Previous Track (Only work under USB & BT Mode).
4. : Play/Pause (Only work under USB and BT mode)
 : Press to Mute or unmute on other modes.
5. Volume- : Master Volume Decrease.
6. EQ : Press to select Music, Movie, News and Sport EQ modes; Press and hold button more than 3 seconds to toggle Surround effect ON / OFF.
7. INPUT : Press to select AUX / USB / TV (ARC) / Optical IN / BT input mode.
8. PAIR : press and hold button more than 2 seconds for BT device pairing or reconnect last paired BT device.
INFO : Press button In short time to check signal format on TV-eARC / Optical mode base on device with Dolby decoder.
9. Next button : Next track. (Only work under USB & BT mode of smartphone)

10.  : Setup, press the button to switch to adjust increasing/decreasing of Bass, Treble, Center, Surround level.
11.  : Under setup button to adjust increasing of Bass, Treble, Center, Surround level.
12.  : Under setup button to adjust decreasing of Bass, Treble, Center, Surround level.

Operating Range of the Remote Control

- When the unit is mounted on a wall, point the remote control at the remote control sensor on the bellowed panel. The provided Remote Control allows the unit to be operated from a distance.
- Even if the Remote Control is operated within the effective range 26.2 feet (8m), remote control operation may be impossible if there are any obstacles between the unit and the remote control.
- If the Remote Control is operated near other products which generate infrared rays, or if other remote control device using infrared rays are used near the unit, it may operate incorrectly. Conversely, the other products may operate incorrectly.

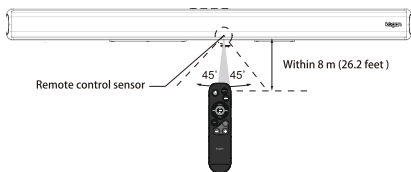

Pair up with the surround

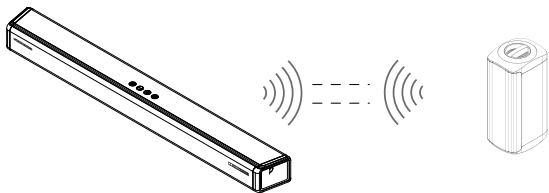

1. Plug the soundbar into the main socket and press "POWER/STANDBY" to turn on the soundbar, then press "INPUT" on the soundbar to switch to the BT mode.
2. Power on rear surround speakers. The blue LED indicator on the surround will blink slowly which indicates entering into pairing mode between soundbar and the wireless surround.
3. Then long press the "switch button" on the bottom of the rear surround for around 2.5 seconds. The blue indicator blinks quickly for waiting for the soundbar and rear surround to automatically pair.
4. Once paired, the blue indicator of the rear surrounds changes to steady on. The soundbar and rear surround are matched successfully automatically.
5. The devices will be able to pair automatically after the initial successful pair, even if they are switched off and on.
6. If you want to pair your wireless surround with another soundbar, please repeat step 1 to step 4 above. Ensure that the soundbar you

want to pair with the surround are within range turned on and any other pairing devices are switched off or on standby.

Remark:

1. If the wireless surround speaker is turned on, but the sound bar is in standby mode or turned off (no power), the flashing blue indicator light of the wireless surround speaker will become red, which means that wireless surround speaker enter into the standby state.

2. In order to avoid receiving wireless signal interference, when you are playing this wireless sound bar system, please keep this wireless sound bar system from your other wireless devices and 2.4G devices at a proper distance.

3. The maximum connection distance between wireless surround and Sound bar: within 10 meters in the open space.

Pair up with the subwoofer

Plug the soundbar and the subwoofer into the mains sockets at the same time

1. Press "STANDBY" to turn the soundbar on. Then press "INPUT" to select BT as the input mode. This will cause the soundbar to enter into pairing mode with the wireless subwoofer.

2. Switch the subwoofer on. The blue LED will blink slowly indicating the unit have power but need to be paired with the soundbar. Press and hold the PAIR (AUTO PAIR BUTTON), the blue LED will flash quickly indicating they are now in pairing mode.

3. After about 20-30 seconds, the blue LED of

the subwoofer will stop flashing and remain blue to confirm a successful pairing with the soundbar.

4. The units will now be able to pair automatically after this initial successful pair, even if they are switched off and on.

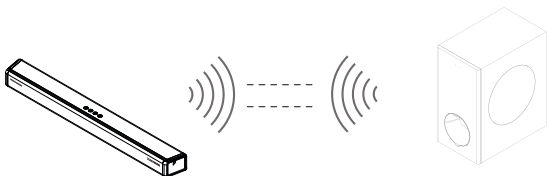

Positioning the Sound Bar

Place on a flat Surface

Place the sound bar horizontally on a flat surface such as a TV unit or shelves and align it centrally with the TV screen. Allow some space between the speaker and the wall. Don't place inside a cabinet or on a walled shelf. Follow this steps for best sound output and good airflow around the sound bar.

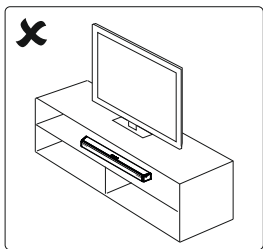
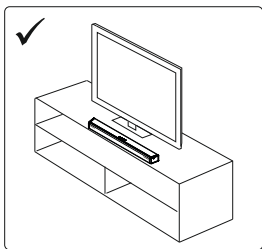

Mount on the wall

WARNING : If you don't feel confident to correctly and securely wall-mount the sound bar, Seek the assistance of an experienced person or professional.

Install the speaker on a vertical, fast, reinforced area of wall. For plaster walls, it is recommended to screw into wall studs for greater security. For optimum performance, allow at least 25mm/1" distance between the sound bar and the TV.

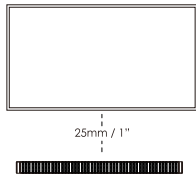
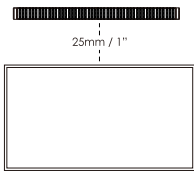

Follow below steps to mount the sound bar on the wall

1. Open 4 holes in the wall referring to iron bracket for wall mounting, the spacing of the holes in the wall is corresponding to the distance between sound bar pads.
2. Fix the plastic anchor in the 4 holes of the wall mounting bracket.
3. Fix the screws on the plastic anchor and tighten the screws to ensure that the wall mounting bracket will not shake.
4. After fastening the screws, Put the sound bar pads into the extension of the wall mounting bracket.

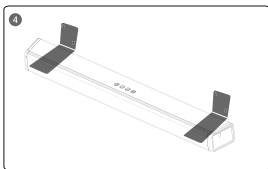
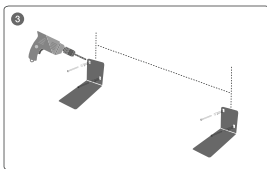
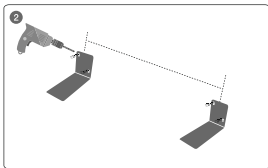
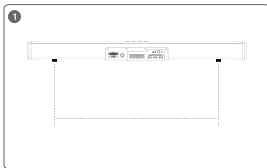

Follow below steps to mount the surround speaker on the wall

1. Open 2 holes on the wall referring the distance of the holes in the bracket.
2. Fasten the plastic anchors in the 2 holes of the wall mount bracket.
3. Then attach the provided screws to the plastic anchors and tighten the screws to ensure that the wall mount bracket does not shaking.
4. Place the surround speakers on bracket with the corresponding holes at the bottom, then fix the provided screws in the bottom of the bracket and the holes of the surround speakers, then tighten the screws.

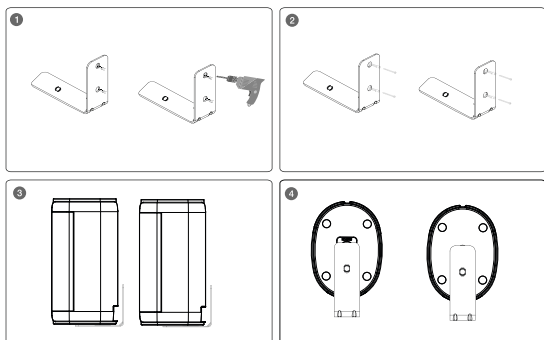

Using the Soundbar

- Before connecting the AC power cord, ensure you have completed all other connections.
- Risk of product damage! Ensure that the power supply voltage corresponds to the voltage printed on the back or the underside of the unit.
- Connect the mains cable to the AC IN of the unit and then into a mains socket.
- Power cord quantity and plug type vary by regions.



Basic Operation

1. Press the power button on either the remote control or the soundbar to turn on the soundbar.
2. Switch on the connected device (such as TV, playback devices, game console etc).
3. Press the input button on either the remote control or the soundbar to select your desired input source.

Input Source	Description
TV(eARC) / OPTICAL	Audio from TV (via TV(eARC)/TV(ARC) port or OPTICAL jack)
AUX	Sound from a connected device (via AUX port)
BT	Sound from a BT connected device
USB	Sound from a USB storage device

Note : Keep the soundbar display mode to be same as your selected input source. For example, if your selected input source is BT, you should see BT displayed on soundbar in the meanwhile.

Powering On/Off

1. Plug in the power cord with one side to AC IN on soundbar and the other side to an AC wall outlet (see the following diagram).
2. Switch on the soundbar by short-pressing the  button on soundbar or on remote controller, After 12s, the default input mode will automatically appear on display screen.
3. Press and hold the  button on soundbar or on the remote controller for 2 seconds to switch it off, and then disconnect the main plug from the main socket if you want to switch the unit off completely.

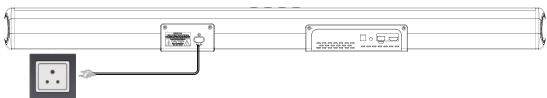

Select Modes

1. Press the button repeatedly on the soundbar or press the INPUT button on the remote control to select the BT, AUX, OPTICAL, TV(eARC), USB mode.
2. Below are input mode names appearing in the soundbar display:

BT - BT Pairing Mode

AUX - AUX Mode

OPT - Optical Mode

ARC - TV(ARC) Mode

eARC - TV(eARC) Mode

USB - USB Mode

The port of TV(eARC) are support Video & Audio

Audio : maximum supported audio content is Dolby Atmos, Dolby Digital, Dolby Digital Plus, Dolby TrueHD, Dolby Surround.

Under TV eARC input souce, if you didn't connect soundbar to your TV, ARC will be displayed on soundbar; If soundbar connected to your TV(eARC) connector, eARC will be displayed on soundbar; If soundbar connected to your TV(ARC) connector, ARC will be displayed on soundbar.

Playing Audio via USB Port

The soundbar automatically switches to USB input mode with the LED display USB when a USB flash drive is inserted (this mode isn't selectable on the soundbar or remote control unless a USB flash drive is connected).

1. Ensure that your USB flash drive contains MP3 audio files (other file types not supported)
2. Connect the USB flash drive to the USB port on the main soundbar (or your own USB extension cable connected to the USB port); music will automatically play with LED display "00:00", when music is played on, the play time will be automatically displayed on the screen.
3. Press the VOL +/- buttons to adjust the volume to your desired level.
4. During playback:

	
Start, Pause or Resume Play.	Skip to the Previous or Next Track.

Playing Audio via BT Connection

Through BT, connect the Soundbar with your BT device (such as an iPad, iPhone, iPod touch, Android phone, or laptop), and then you can listen to the audio files stored on the device through your Soundbar speakers.

What you need

- A BT device which supports BT profile A2DP, AVRCP and with BT version as 5.0.
- The maximum operational range between the Soundbar and a BT device is approximately 8 meters (26.2 feet).

1. Turn on the soundbar system and short-press  button repeatedly on the unit or INPUT button on the remote control to switch the soundbar system to BT mode and LED display BT on the main soundbar will flicker in the BT pairing mode.
2. On the BT device, switch on BT, search for and select **ZEB-JUKE BAR 9775** on your BT list to start connection (see the user manual of the BT device on how to enable BT) if prompted for a password, please use "0000".
3. Wait until you hear the voice prompt from the Soundbar. If the successfully connected, BT stops flickering and is displayed on the display panel.
4. Select and play audio files or music on your BT device.

- During play, if a call is coming, music play is paused. Play resumes when the call ends.

- If your BT device supports AVRCP profile, on the remote control you can press **⏮ / ⏭** to skip to a track, Press and hold the SETUP button for more than 2 seconds to restore factory default settings; Press and hold PAIR button on the remote control for more than 2 seconds to disconnect paired BT device or reconnect last disconnected BT device.

5. You can use the volume buttons on the soundbar or on the remote controller to adjust the volume to your requirements

6. To exit BT, select other relevant input source.

- When you switch back to BT mode, BT connection remains active.

7. Press the VOL +/- buttons to adjust the volume to your desired level.



Notes:

- *Having connection problems? Remove ZEB-JUKE BAR 9775 from your device's BT history and ensure it's less than 8 meters away. Then try pairing again. To get the best sound quality, make sure there is a clear line of sight between the connected device and your soundbar.*

- *If your pairing device or connected device is switched off or manual disconnected, the soundbar will automatically enter pairing mode.*

• The music streaming may be interrupted by obstacles between the device and Soundbar, such as wall, metallic casing that covers the device, or other devices nearby that operate in the same frequency.

• If you want to connect your Soundbar with another BT device, press and hold Pair on the remote control to disconnect the currently connected BT device.

Connections

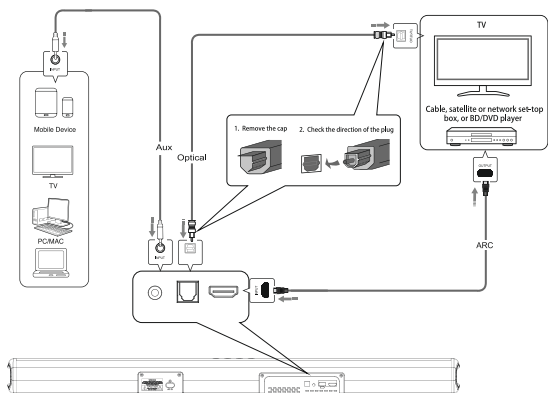

wireless signal

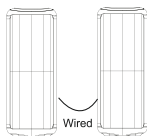

wireless signal

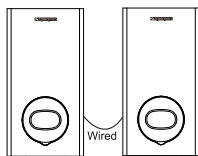

Audio Input (AUX) Connection

Use a 3.5mm to 3.5mm audio cable to connect the PC, tablet, smartphone, TV's headphone socket to the AUX socket on the soundbar.

- Use a RCA to 3.5mm audio cable to connect the Blue Ray DVD Player / TV's audio output sockets to the AUX socket on the soundbar.
- Then short-press the  button on the soundbar or on the remote controller to switch to audio input mode with LED display lighting up AUX.
- In this mode, playback can only be controlled on your connected device

TV (eARC) Mode

Connect to TV(eARC) Socket

Some 4K HDR TVs require the ARC input or picture settings to be set for HDR content reception. For further setup details on HDR display, please refer to the instruction manual of your TV.

Option 1 : TV(eARC) (enhanced Audio Return Channel)

Your Soundbar supports HDMI with enhanced Audio Return Channel TV(eARC). If your TV is TV(eARC), you can hear the TV audio through your Soundbar by using a single ARC cable.

1. Use a High Speed ARC cable, connect TV(eARC) on the soundbar to TV(eARC) connector on your TV.
2. Then short-press  button on the soundbar or INPUT button on the remote controller to switch to TV(eARC) mode. After successfully connected, the LED display will show eARC. (If TV support TV(ARC), LED display will show ARC)
3. Press the VOL +/- buttons to adjust the volume to your desired level.
4. If you wish, you can change the audio settings by using the relevant buttons on the remote controller.

Note:

- Your TV must support the ARC-CEC and TV(eARC) function. ARC-CEC and TV(eARC) must be set to be on.
- The setting method of ARC-CEC and TV(eARC) may differ depending on the TV. For details about TV(eARC) function, please refer to your TV owner's manual.
- Only ARC 1.4 compatible cables can support the TV(eARC) function.
- The enhance Audio Return Channel function enables an ARC compatible TV to send the audio stream to ARC OUT of the unit.

Optical Mode

Using an optical cable, connect the OPTICAL port on your Soundbar (Optical digital input) to the OPTICAL OUT connector on the TV or other device. The TV or other device must have an optical digital output.

Proceed as follows:

- Connect the other end of the optical cable to audio output jack on TV or other device.
- Set TV to PCM Stereo or Stereo 2.0.
- Start playing on the TV
- Press the source input button on the soundbar or remote control to activate the corresponding mode (the OPTICAL mode) to open optical digital input of your soundbar. After successfully connected, the LED display will show OPT. Operate your audio device directly for playback features.
- Press the VOL +/- buttons to adjust the volume to your desired level.

DOLBY ATMOS®

Manufactured under license from Dolby Laboratories. Dolby, Dolby Audio, Dolby Vision, Dolby Atmos and the double -D symbol are trademarks of Dolby Laboratories.

What is DOLBY ATMOS® ?

Dolby Atmos® transports you from the ordinary into the extraordinary with breathtaking, moving audio that fills your room and flows above and around you.

Dolby Atmos® gives you amazing experience you have never heard before by overhead sound, and all the richness, clarity, and power of Dolby sound.

Using DOLBY ATMOS® :

DOLBY ATMOS® is only available in HDMI IN and HDMI OUT (ARC) mode. For the details of the connection, please refer to "HDMI Connection".

1. To use Dolby Atmos® in HDMI 1 /HDMI 2 / HDMI ARC mode, your TV has to support Dolby Atmos®.
2. Make sure that "No Encoding" is selected for bitstream in the digital audio output of the connected external device (e.g. Blu-ray DVD player, TV etc.).
3. While entering Dolby Atmos / Dolby Digital Plus format, the soundbar will show DOLBY ATMOS / DOLBY SURROUND.

4. Set the audio output sampling rate to 192 kHz if you can adjust it. This sound bar supports 4K Pass through and DOLBY VISION. When you play a disc which supports 4K video signal, the signal can be delivered to your TV.

Note:

- *The full Dolby Atmos experience is only available when the Soundbar is connected to the source via a HDMI 2.0 cable.*
- *The Soundbar will still function when connected via other methods (such as a Digital Optical cable) but these are unable to support all of the Dolby features. Given this, our recommendation is to connect via HDMI, in order to ensure full Dolby support.*

Features:

- BT v5.3 | HDMI (eARC) | Optical IN | USB | AUX
- Dolby Atmos
- Dual Wireless Subwoofer
- 5.2.2 CH Surround Sound
- Dual Wireless Rear Satellites
- Soundbar with 5 Drivers
- Wall Mountable
- LED Display
- Remote Control

Specifications

Output Power

Subwoofer	: 140W x 2
Sound Bar	: 270W
Satellites	: 50W x 2
Total	: 650W

Driver Size

Subwoofers	: 16.51 cm x 2
Sound Bar	: (6.35 cm x 3) + (5.08 cm x 2)
Satellites	: (7.5 x 5.2 cm) x 2

Impedance

Subwoofer	: 3Ω x 2
Sound Bar	: 8Ω x 5
Satellites	: 8Ω x 2

Frequency Response : 45Hz-20kHz

S/N Ratio : ≥66dB

Separation : ≥35dB

File Format Support : MP3 (USB)

Line Input	: 3.5mm, Optical IN, TV (eARC)
Max Supported Memory Size (USB)	: 32 GB
BT Name	: ZEB-JUKE BAR 9775
BT Version	: v5.3
Product Dimension (W x D x H)	
Subwoofer	: 19 x 30.6 x 36.7 cm
Sound Bar	: 96 x 10.7 x 7.7 cm
Satellite	: 7.3 x 10 x 19 cm
Net. Weight	
Subwoofer	: 4.45 kg x 2
Sound Bar	: 3.18 kg
Satellite	: 560g x 2
Total	: 13.2 kg

Troubleshooting

PROBLEM/TROUBLE	POSSIBLE CAUSE	SOLUTION
There is no sound output from sound bar.	Another input source is selected.	Select an appropriate input source.
	The mute function is activated.	Cancel the mute function.
	The volume of sound bar or TV/other device is adjusted too low.	Increase the volume level on sound bar or by remote control or on TV.
	The power cable of the unit is not connected properly.	Make sure that the power cable of the unit is connected to an AC wall outlet securely.
	Input jacks on a playback device are connected.	Connect the input jack on the sound bar and the output jack on the playback device.
	Signals that the sound bar cannot playback when being input.	When sound bar and TV or other devices are connected by an audio cable through TV (ARC) port output, Select the correct audio input and output. Make sure the digital audio output setting on the playback device to PCM format. Since the output format of our sound bar is PCM, if it is used, the decoding format of TV or other devices will be adjusted to PCM state.
The sound is distorted or echoed.	TV volume is not muted.	If you play audio from TV through the sound bar, make sure that the TV is muted.
The volume decreases when the unit is turned on.	The automatic volume adjustment function is activated. To prevent excessive loudness, the unit automatically controls its volume within a certain level when the unit is turned on.	Turn up the volume as required.
Noise is heard.	The sound bar is too close to another digital or high-frequency device.	Move those devices away from the sound bar.
The unit cannot be operated by using the remote control.	The unit is out of the operating range.	Use the remote control within the operating range.
	The batteries are weak.	Replace with new batteries.
	The remote control sensor of the sound bar is exposed to direct sunlight or strong lighting.	Adjust the lighting angle or reposition the sound bar. Make sure our product cannot be used in sunlight.
The TV cannot be operated by using the TV's remote control.	The unit is blocking the TV's remote control sensor.	Position the unit so that it does not obstruct the TV's remote control sensor.
A device cannot connect the sound bar or the unit cannot be connected to a BT device.	BT function of the device is not activated, not paired or connected correctly.	Restart the sound bar and try pairing again. You have not enabled the BT function of the device; see the user manual of the device on how to enable the function and correctly connected the device. The sound bar is already connected with another BT device. Disconnect the connected device, and then try again.
	BT is not selected as the input source.	Select BT as the input source.
	The unit is connected to a different BT device.	Un-pair the BT device that is currently connected and pair with the desired BT device.
	The unit is too far away from the BT device.	Move the BT device closer to this unit.
	A device emitting electromagnetic waves (such as a microwave oven, a wireless device and so on) may be placed nearby.	Do not use this unit near devices that emit electromagnetic waves.
	The BT device that you are using may not support the protocol.	Use a BT device that supports the protocol.
	The connection profile registered in the BT device may not be functioning correctly for some reason.	Delete the connection profile in the BT device and then connect the BT device to this unit.
Sound quality of audio play from a connected BT device is poor and connection is not stable.	The BT reception is poor.	Move the device closer to the sound bar, or remove any obstacle between the device and the sound bar.
No sound can be heard or sound breaks (BT mode)	The volume on the BT device may be too low.	Raise the volume on the BT device.
	BT is not selected as the input source.	Select the BT as the input source.
	Playback on the device has not been performed.	Perform playback on the device.
	The sound output on the BT device may not be set to this unit.	Select this unit as the output device on the BT device.
	The connection to the BT device was cut off.	Connect with the BT device one more time.
	The unit may be too far away from the BT device.	Move the BT device near this unit.

PROBLEM/TROUBLE	POSSIBLE CAUSE	SOLUTION
	A device emitting electromagnetic waves (such as a microwave oven, a wireless device and so on) may be placed nearby.	Do not use this unit near device that emit electromagnetic waves.
There is no sound from sound bar - TV (eARC) Mode	Incorrect HDMI cable is used causing no signal to be sent to soundbar. Incorrect input mode is selected.	1. Make sure that the user connected TV and sound bar by a 19-core ARC cable. 2. The soundbar and TV are connected through TV(eARC) Cport output; make sure that the TV is TV(eARC) or TV(ARC) compliant. 3. Set the TV to TV(eARC) or TV(ARC) (CEC). Set the audio output mode of TV to PCM format. (Or refer to your TV user manual)
There is no sound from sound bar (OPTICAL Mode)	OPTICAL cable might be damaged and no signal is received by the soundbar due to a failed connection and incorrect operation mode selected.	1. Replace the OPTICAL cable with a new one to connect. 2. Set your TV audio output to PCM format. (Pls refer to your TV user manual)
There is no sound from sound bar (USB mode)	USB file type is not support & Sound bar doesn't switch to USB input mode automatically when USB is inserted.	Make sure that USB flash drive contains MP3 files because other file types are not supported. Switch the input mode once again, then playback again.
Disconnected between surround satellites and soundbar	Connection is not correct between surround satellites and soundbar.	1. Turn off soundbar and surround satellites by removing the AC plug from the socket. 2. Make sure that soundbar and surround satellites are connected to the electricity power at the same time , and switch on soundbar and surround satellites again.
There is no sound output from rear active speaker	Power input or pair connecting issue.	1. Check the adaptor input 2. Pair again with soundbar
There is no sound output from rear passive speaker	Cable connecting issue.	Check again connected cable between active rear speaker
Inverse channel from R to L	Speaker position confusion.	Press R/L switch button from active rear speaker
Noise is happened from rear speakers	BT connecting or poor signal.	1. Disconnect & connect with soundbar again 2. Power off and on for soundbar and rear active speaker again.

ISO 9001:2015 Certified Company
www.zebronics.com

